



공방이방지



품질보증



위생·안전품질획득



KS마크획득



ISO9001인증업체



KAB

열경화성수지천정판

SMC / BMC

SHEET MOULDING COMPOUND
BULK MOULDING COMPOUND



성수산업(주)

www.nezangze.co.kr

열경화성수지천정판

SMC/BMC

■ 피스톤 신제품

- 피스타입으로 바람에 강하다
- 시공이 간편하다
- 컬러도 다양하다

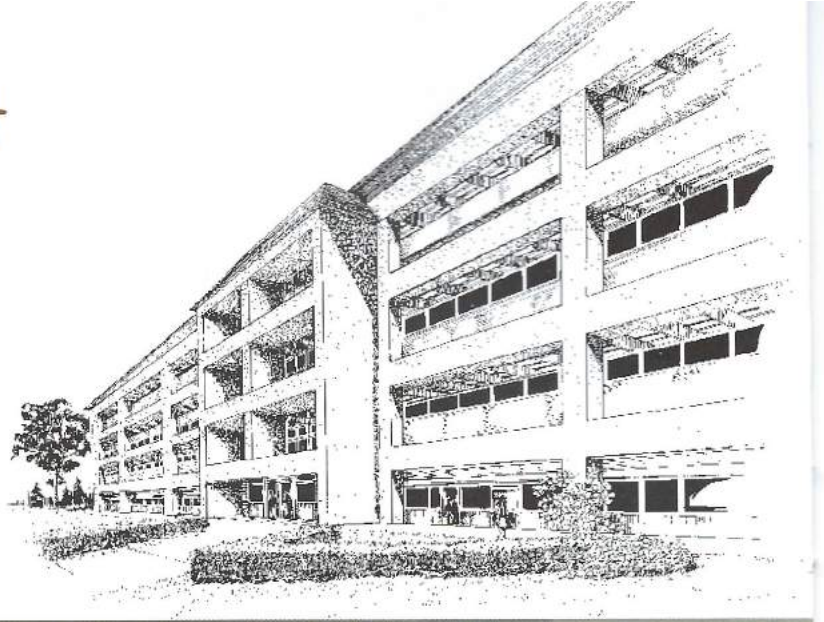

열경화성수지

SMC(SHEET MOULDING COMPOUND)

고온 고압의 PRESS를 사용하여 불포화 폴리에스테르, 보강재, 난연재, 착색재, 이형재 등을 혼합한 접착성 있는 SHEET상태를 만들어 STEEL MOLD를 이용 성형하는 특수 복합재료임

BMC(BULK MOULDING COMPOUND)

불포화 폴리에스테르와 GLASS FIBER와 충전재, 저수축재, 경화재, 난연재, 이형재, 첨가재를 혼합시킨 복합 성형 재료임

내습성 및 유지보수성이 우수하고 시공이 간편한 제품입니다.

■ 열경화성수지소재의 특징

- 다양한 디자인과 색상으로 우아하고 아름다운 분위기를 연출하실 수 있습니다.
- 표면이 미려하고, 고강도의 제품으로 구성이 우수합니다.
- 수분, 염분, 기타 화학물 등에 강하여, 부식 및 변형, 변색이 없습니다.

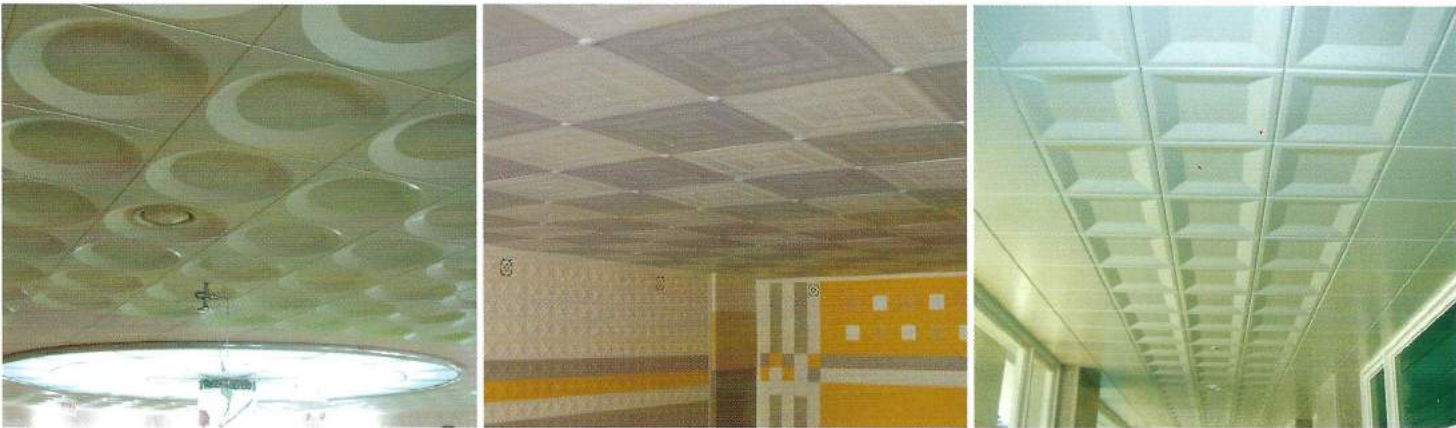

난연제품이란

난연합판, 난연섬유판, 난연플라스틱 등 본래는 연소하는 유기질 재료를 약품가공함으로써 연소되기 어렵게 한 건축재료를 말한다.

제품소개

원형

1 원SS-66



2 원SS-45



3 원SS-36



4 원SS-33



규격

- 1 600mm X 600mm X 1.2T
- 2 450mm X 450mm X 1.2T
- 3 300mm X 600mm X 1.2T
- 4 300mm X 300mm X 1.2T

사각

1 사SS-66



2 사SS-45



3 사SS-36

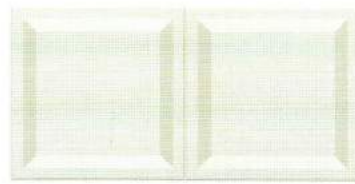

4 사SS-33



규격

- 1 600mm X 600mm X 1.2T
- 2 450mm X 450mm X 1.2T
- 3 300mm X 600mm X 1.2T
- 4 300mm X 300mm X 1.2T

평판

1 평SS-66



2 평SS-45



3 평SS-36



4 평SS-33



규격

- 1 600mm X 600mm X 1.2T
- 2 450mm X 450mm X 1.2T
- 3 300mm X 600mm X 1.2T
- 4 300mm X 300mm X 1.2T

무늬

1 반달-66



2 꽃무늬-66



3 꽃무늬-36



규격

- 1 600mm X 600mm X 1.2T
- 2 600mm X 600mm X 1.2T
- 3 300mm X 600mm X 1.2T

피스톤

1 피SS-66



규격

- 1 600mm X 600mm X 1.2T

열경화성수지천정판 | 원형

BMC / SMC



규격

원SS-66

원SS-36

원SS-33

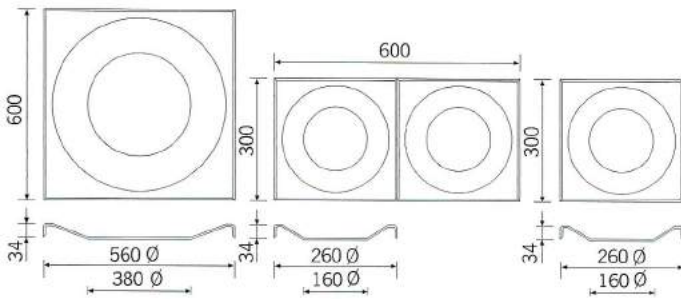

- 색상 : 9페이지 참고
- 용도 : 사우나, 수영장, 현관, 화장실, 샤워장 외
- 특징 : 부드러운 느낌을 줌으로 대중적인 장소에 사용을 많이하여 가장 많이 쓰이는 제품임



BMC / SMC



규격

사SS-66

사SS-36

사SS-33

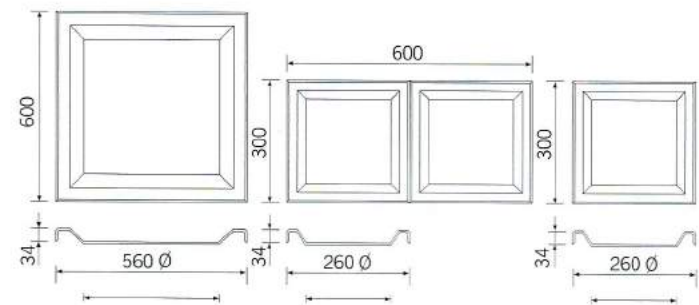

- 색상 : 9페이지 참고
- 용도 : 현관, 사무실, 복도 외
- 특징 : 정리정돈 느낌을 줌으로 정서적인 곳에 많이 사용함.



열경화성수지천정판 | 평판

BMC / SMC

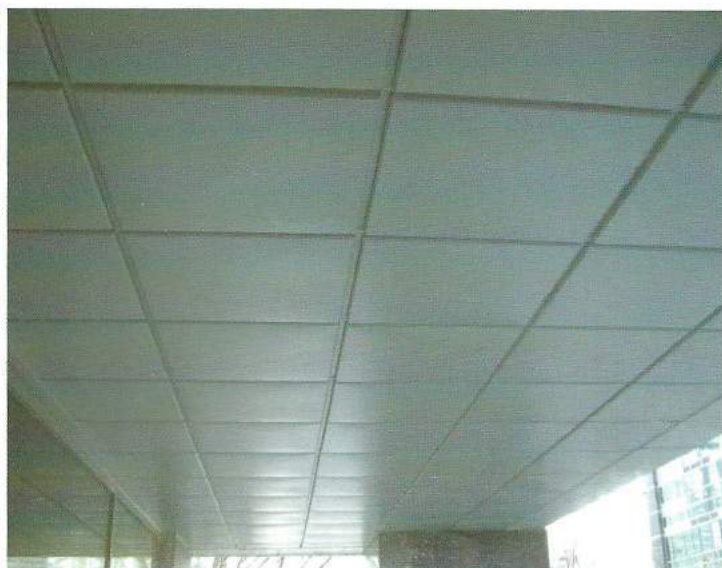

규격

평SS-66

평SS-36

평SS-33

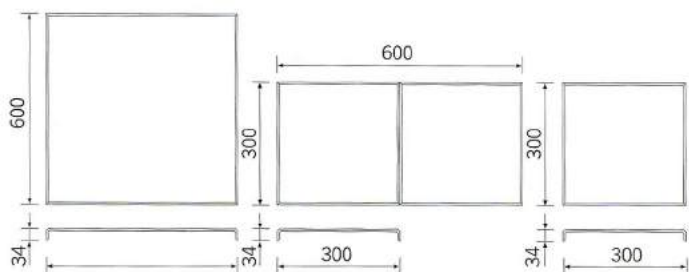

- 색상 : 9페이지 참고
- 용도 : 사무실, 현관, 사우나, 수영장, 화장실, 샤워장 외
- 특징 : 수평적인 느낌을 줌으로 넓게 보이기 위한 곳에 주로 사용하며, 일반제품의 마무리 작업에 절단하여 사용함



설치시공예



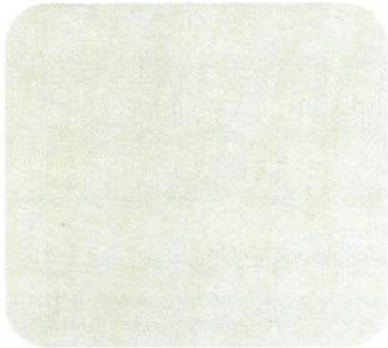

S-01 아이보리

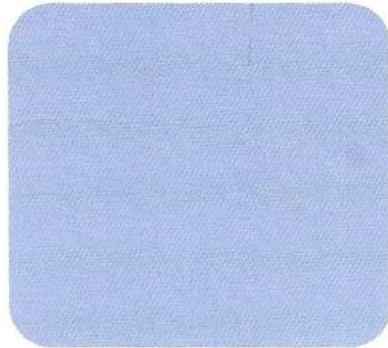

S-02 다크블루

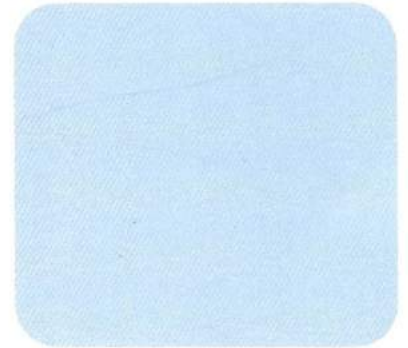

S-03 블루

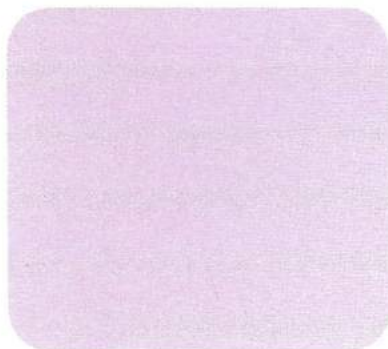

S-04 다크핑크

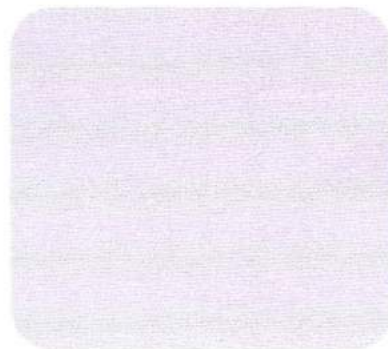

S-05 핑크

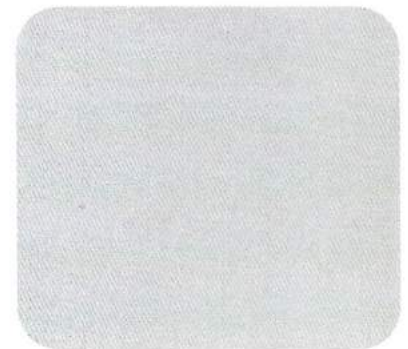

S-06 그레이

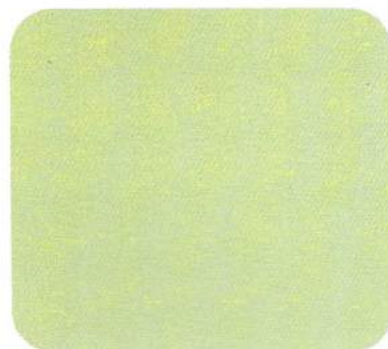

S-07 그린

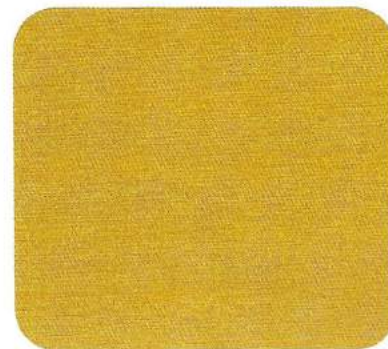

S-08 골드

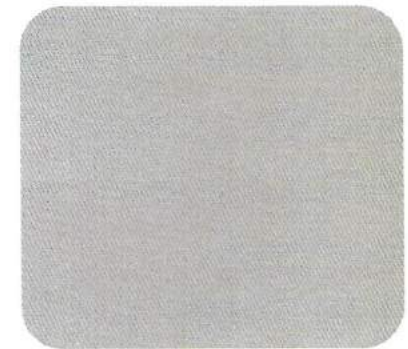

S-09 실버

※ 카다로그 색상은 제품색상과 다소 차이가 있음.
※ 카다로그 색상 외 특수칼라 주문시 생산가능함.

한지보드

종료섬유(Palm Fiber)를 사용하여 표면에 불규칙적인 무늬가 새겨지므로 한지와 같은 자연친화적인 분위기 및 질감을 제공함.

※ 시공법은 열경화성수지 천정판 크립바 시공법과 동일함.



색상



HG-01 아이보리



HG-02 그레이



HG-03 노랑



HG-04 진노랑



HG-05 연두



HG-06 진연두



HG-07 핑크



HG-08 진핑크

※ 카다로그 색상은 제품색상과 다소 차이가 있음.

※ 카다로그 색상 외 특수칼라 주문시 생산가능함.

※ 규격, 모양 4페이지 동일

CLIP-BAR시스템(시공법)

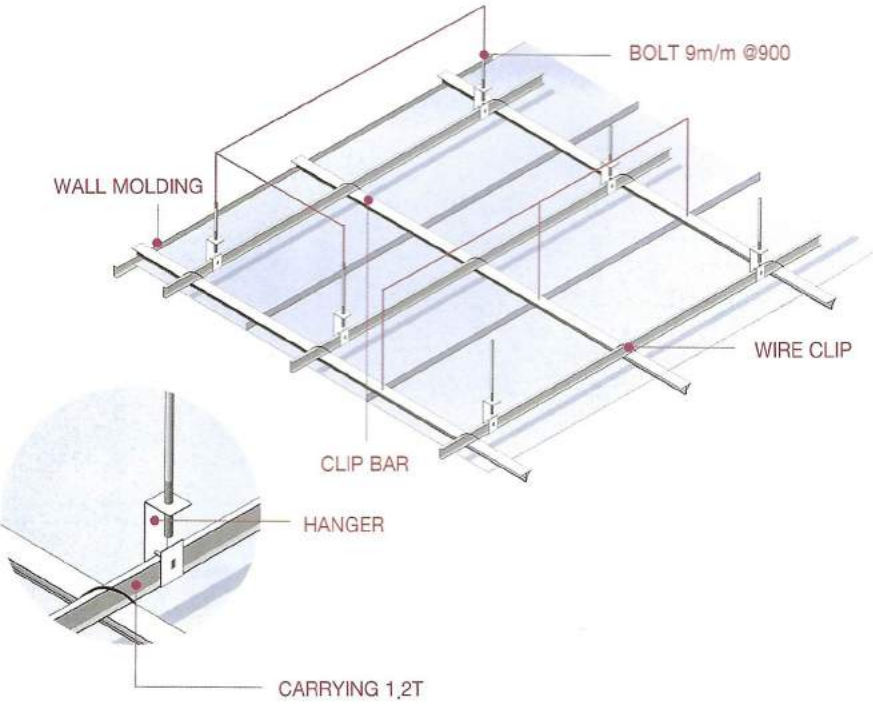

CLIP-BAR 시스템

보편화된 TILE결작 SYSTEM으로 CLIP-BAR를 이용하여 시공이 간편하고 견고한 구조체를 형성합니다. TILE 넓이 간격으로 CLIP-BAR를 설치하고 800 ~900mm 간격으로 CARRYING CHANNEL이 보강됩니다.

시공방법

1. 행거볼트용 인서트 설치
2. 행거볼트 부착
3. 행거설치
4. 캐링설치
5. 크립바 설치(와이어크립 사용)
6. 마감처리용 몰딩설치
7. 크립바에 SMC천정판 결합

- 일반적으로 가장 많이 사용되는 공법이며 나사못 시공으로 간편하고 견고한 시공법입니다.
- 등라인 설정 후 캐링채널, 마이너채널, CLIP-BAR등의 순으로 설치합니다.

KS부자재 규격

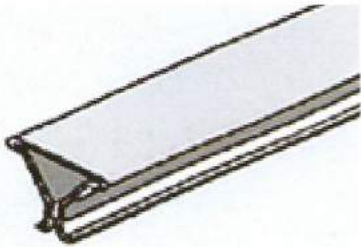

■ 클립바(CLIP BAR)

- 높이 : 29mm
- 폭 : 35mm
- 길이 : 4,000mm
- 재질 : 아연도금강판

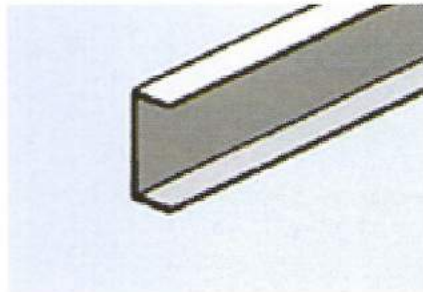

■ 캐링(CARRYING)

- 높이 : 38mm
- 폭 : 12mm
- 길이 : 4,000mm
- 재질 : 아연도금강판(1.2mm)



■ 행거볼트(HAANGER BOLT)

- 직경 : 9mm
- 길이 : 1,000mm ~
- 재질 : 아연도금강철



■ 행거(HANGER)

- 규격 : 38mm
- 재질 : 아연도금강판(1.2m)



■ 와이어클립(WIRE CLIP)

- 높이 : 29mm
- 폭 : 35mm
- 재질 : 아연도금강판

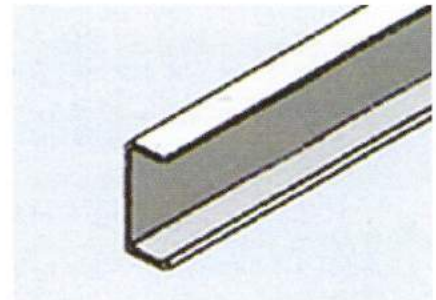

■ 타일몰딩(TILE MOULDING)

- 높이 : 26mm
- 폭 : 15mm
- 길이 : 4,000mm
- 재질 : 1.2m알루미늄(소부도장 재질변경 가능)

인증서

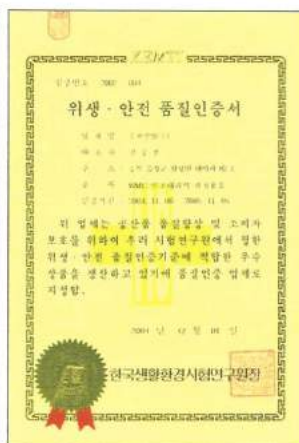
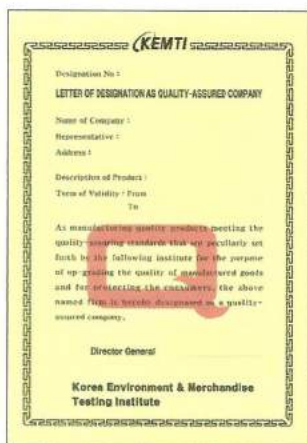
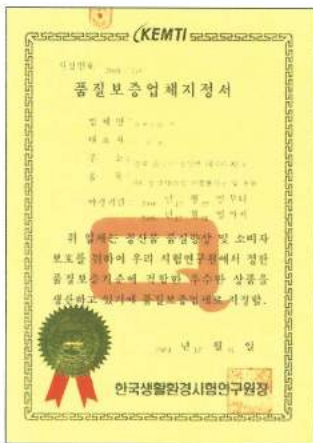

성수산업(주)

- 영업소 : 서울특별시 서초구 방배본동 792-1 길주빌딩 2층
전화 : 02-595-3301 팩스 : 02-535-3544
- 물류창고 : 경기도 화성시 봉담읍 유리 63번지
전화 : 031-366-1946 팩스 : 031-366-1947
- 합자공장 : 충북 음성군 삼성면 대야리 82-1
E-mail : sungsu@nezangze.co.kr
Http://www.nezangze.co.kr